

Welding-head DK-2004

- The specialist for filigrane applications

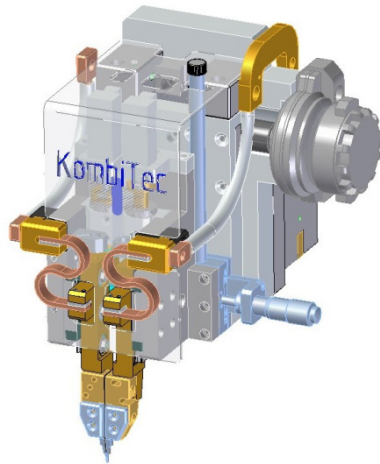

- 0,2 - 10N Welding force
- Hub: 15mm, individual customizable
- Electrode gap adjustable through micrometerscrew in a 0,01mm area
- Wide: 147mm
- Hight: 220mm

Welding-head SK-2012

- The light "wonder of space"

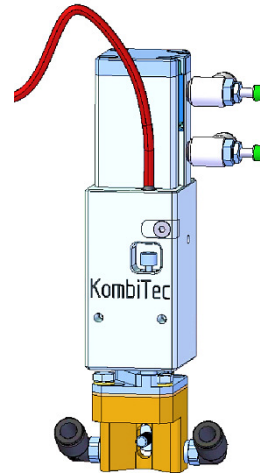

- 140N Welding force
- Lifting: 8mm, individual customizable
- Extremely low self-weight of 432g
- Attrition free, sealing free zylinder
- High lifeduration through a selfcleaning guide
- Wide: 32mm
- Hight: 140mm
- Depth: 40mm



- Micro-Resistance-Welding
- Special engineering
- Automized systems
- Small slides
- Contract welding
- Laboratory
- Seminars



Fully-automatic machine



Workstation

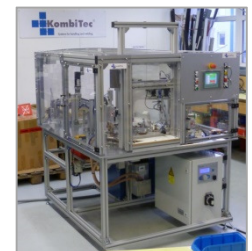

Half-automatic machine

Compacting KWZ-10

- Easy and safe from 0,5mm² -12,0mm²

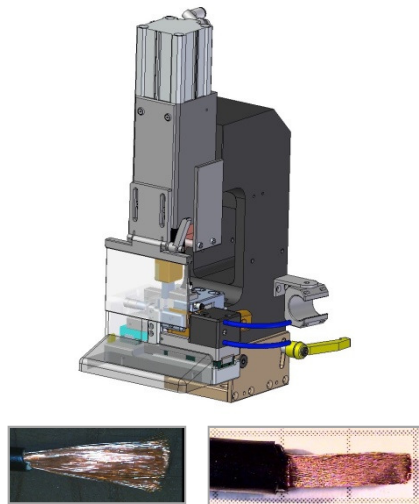

KompaTec²

- Easy and safe from 0,5mm² -5,0mm²

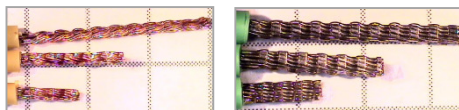
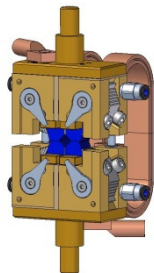

Welding-pincer SZ-2030

- The revolutionary recent development

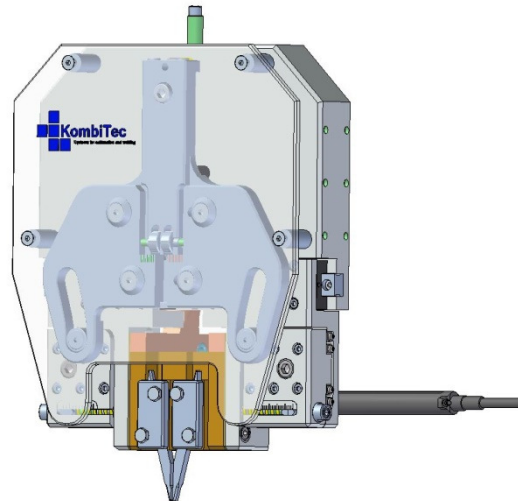

- 300N Welding force
- Low self weight of 4,8kg
- Cam-controlled, customizable
- Extremely flat shape
- Wide: 185mm
- Hight: 215mm
- Depth: 66mm



Competence:

- Innovative and future oriented actions
- Know-How in all areas of the Micro-Resistance-Welding
- Converting individual requirements

Safety:

- DIN ISO 9001:2008 certified
- Member of the DVS



KombiTec GmbH
Westendstraße 5
D-87488 Betzigau

Telefon: +49 (0)831-96 03 98-0
Telefax: +49 (0)831-96 03 98-10
email: info@kombitec.de
www.kombitec.de